

ONE-HOUR-RIM BOARD ASSEMBLIES - LOAD TRANSFER - ASSEMBLY NO. 2

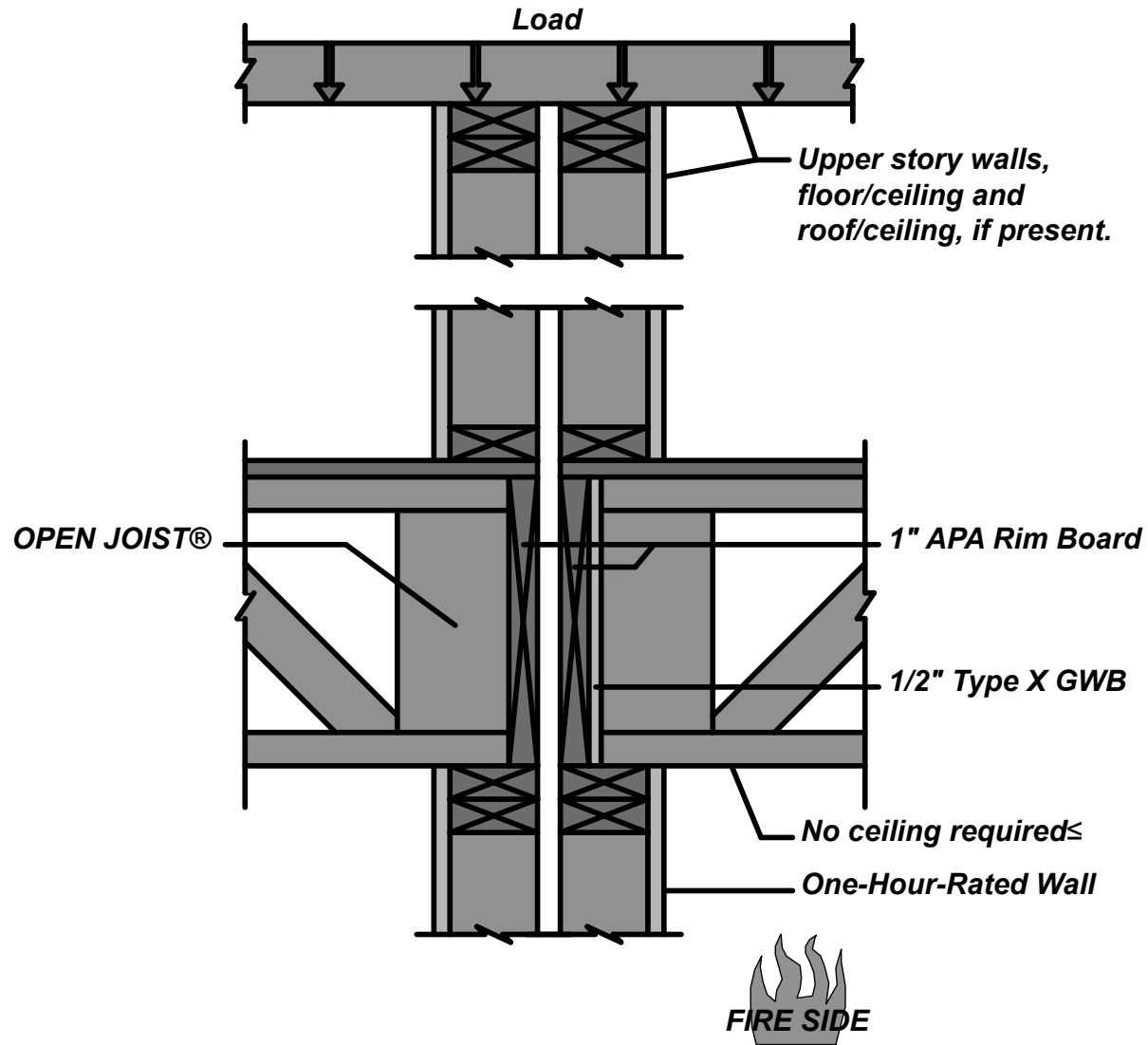

FIRE ASSEMBLY NO. 2