

ONE-HOUR-RIM BOARD ASSEMBLIES - LOAD TRANSFER - ASSEMBLY NO. 3

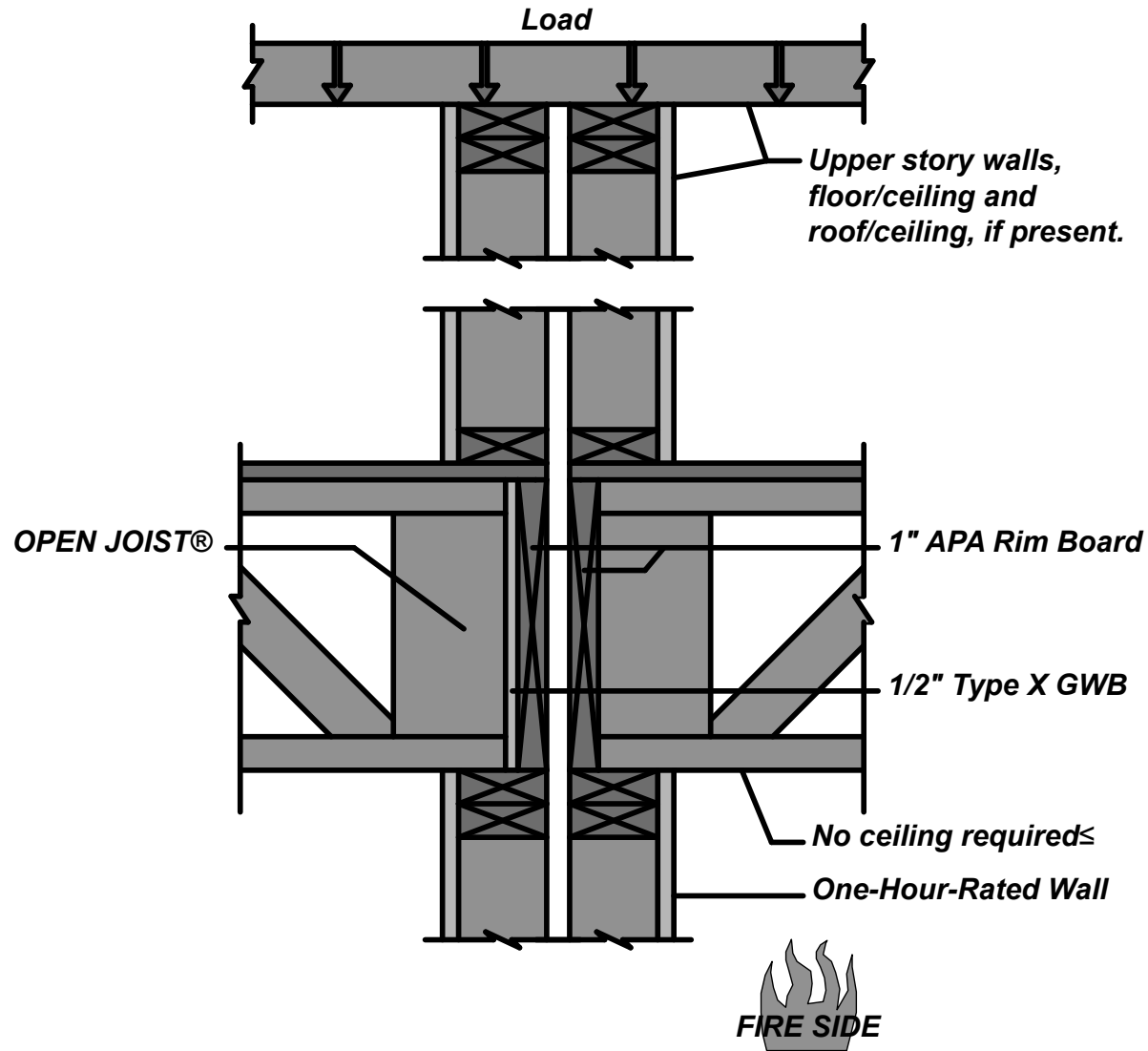

FIRE ASSEMBLY NO. 3